

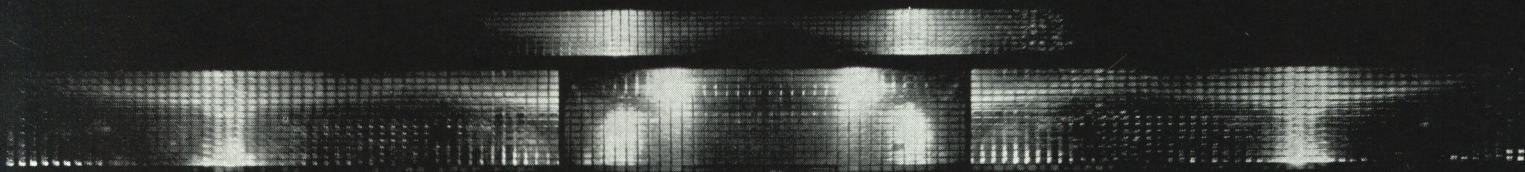

**OWENS-ILLINOIS**

**INSULUX**

**GLASS BLOCKS**





# TRANSLUCENT MASONRY

OF OWENS-ILLINOIS

## INSULUX

### *Glass Building Blocks*

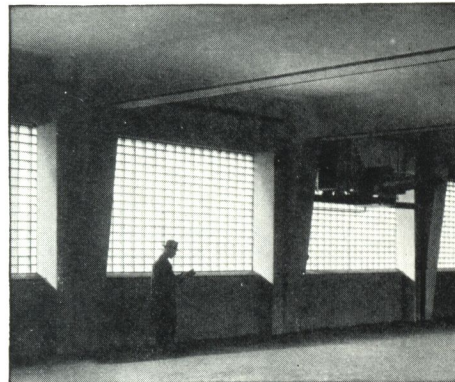

• The following pages tell the story of Glass Masonry—a product demanded by the functional and aesthetic requirements of present-day building. Owens-Illinois Glass Masonry Blocks combine properties that are available in no other one building material. The research and manufacturing facilities of the Owens-

Illinois Glass Company have made possible the economical production of Glass Masonry Blocks distinguished by low heat conductivity, great structural strength and desirable light transmitting and diffusing properties.

#### TABLE OF CONTENTS

General Description .....	page two
Standard Sizes .....	three
Light Transmission and Diffusion .....	three and four
Structural Strength .....	five
Resistance to Heat Loss .....	five
Sound Deadening .....	six
Fire Resistance .....	six
Moisture Penetration .....	six

Cleanliness and Maintenance .....	six
Removal and Replacement .....	six
Uses of Insulux Masonry .....	six
Details of Construction .....	seven to fifteen
Basic Specifications .....	sixteen
Scientific Test Data .....	sixteen
Cost of Insulux Masonry .....	sixteen

OWENS-ILLINOIS GLASS COMPANY • GLASS BLOCK DIVISION • MUNCIE, INDIANA



## GENERAL DESCRIPTION OF INSULUX GLASS MASONRY



Insulux Glass Blocks are light in weight and are of a size that is convenient for the mason to handle. They lay up quickly in the same manner as other masonry units.

Owens-Illinois Glass Blocks are hollow, partially evacuated, translucent units of water-clear glass. They are laid up by masons using ordinary mortar joints. They are suitable for functional uses as light-transmitting walls of high thermal resistance; they offer a wide range of decorative possibilities. Insulux Glass Blocks possess properties and advantages unique in the field of building materials.

**ECONOMY**—Exclusive manufacturing developments make Insulux Translucent Masonry lower in cost than other glass masonry construction, and compare with the cost of walls and average quality glazed steel sash.

**LIGHT TRANSMISSION**—Variations in the prismatic patterns impressed upon the faces of the blocks result in light-transmitting values and diffusing properties over a wide range, with an absence of glare, affording light comparable to that from northerly exposed windows or skylights.

**UNIFORMITY**—Rigid inspection and the Owens-Illinois manufacturing process produce a block of unvarying characteristics.

**STRENGTH**—Insulux Glass Blocks have high compressive, lateral, impact and bond strength.

**THERMAL RESISTANCE**—Insulux Glass Blocks prevent infiltration losses, their heat conductivity is low, they reduce the effect of solar radiation.

**SOUND TRANSMISSION**—Glass Block walls possess a well-defined deadening effect against the transmission of sound.

**FIRE RESISTANCE**—Insulux Glass Masonry walls, due to their double faced construction and thickness, provide remarkable resistance to fire attack.

**MOISTURE**—The partial vacuum of dry rarefied air prevents condensation inside the blocks. In still air the outdoor temperature necessary to produce surface condensation on the inside of an Insulux Glass Masonry wall is minus 16.4°F. with an inside temperature of 70°F. and a relative humidity of 40%. (Purdue University test.)

**CLEANLINESS**—Insulux Glass Masonry walls are easy to clean and maintain. They are non-absorbent to liquids or odors.

**PRACTICALITY**—Experience with glass blocks has established their practical value over a period of years.

**REPLACEMENT**—The simplicity of the mortar joint makes removal and replacement easy.

From these features and advantages, it can be easily seen that Insulux Glass Blocks possess characteristics not found in other types of masonry or in other glass building units.

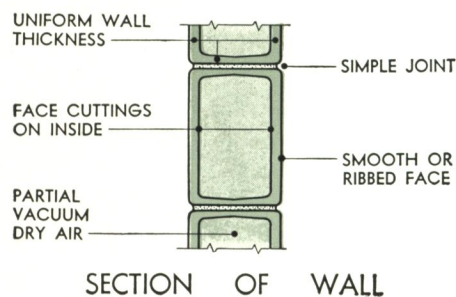



## STANDARD SIZES

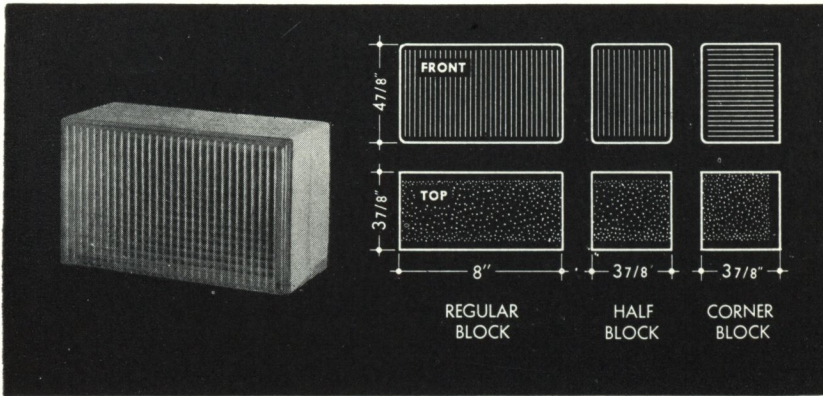

**NO. 1 SERIES**—This block bonds with 2 courses of ordinary brickwork. Square corner blocks and half blocks to be used in starting panels of Running Bond are standard. Owens-Illinois Glass Blocks are standard in 3 sizes. The use of standard sizes results in the most economical glass masonry construction now known to the building industry.

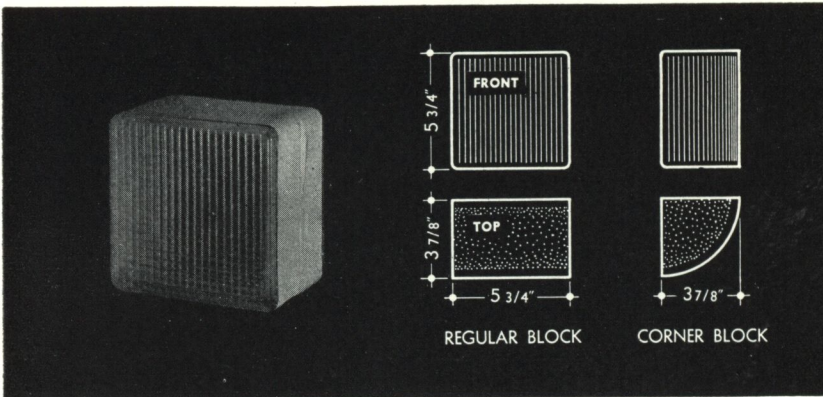

**NO. 200 SERIES**—This block is particularly suited to Checkerboard Bond. Rounded corner blocks are standard in this series. Beyond the standard sizes referred to, on special order we can furnish extra large sizes, such as 11 3/4 x 11 3/4 x 3 7/8 in., and larger oblong styles.

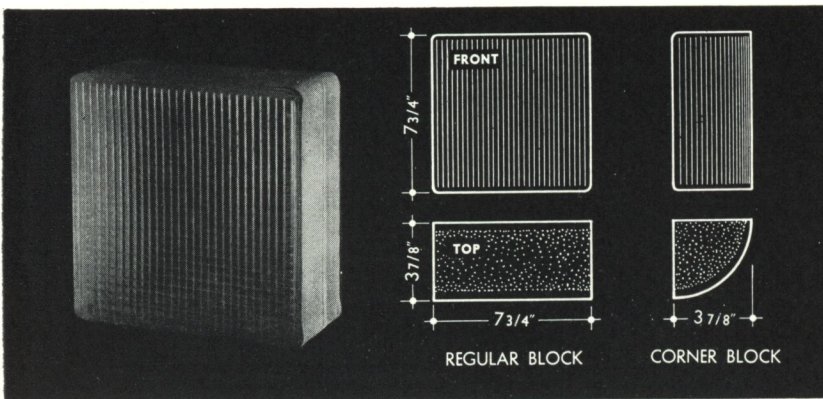

**NO. 300 SERIES**—The larger size square blocks are ideally suited to larger areas and to particular design requirements. Rounded corner blocks are standard in this series. Variation in the selection of the face cuttings, bond, joint pointing, color of mortar joints—combine to offer an almost unlimited range of decorative possibilities.

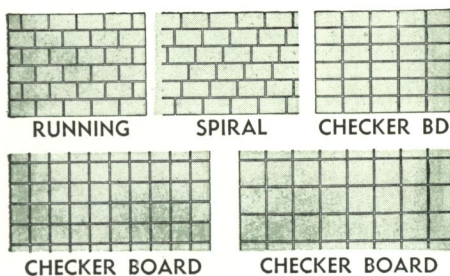

## LIGHT TRANSMISSION AND DIFFUSION

All standard sizes of Insulux Glass Blocks are available in the 4 standard cuttings shown. The various face cuttings have been arrived at through extensive research to obtain an interesting decorative quality, combined with a variation in the light transmission coefficients. The design of the cuttings does not permit a lens effect, thus avoiding glare or a spotty concentration of light.

Owens-Illinois Insulux Glass Blocks are translucent—permitting the transmission of light while effectively obscuring images. The prismatic cuttings create a pattern which serves as a screen, improves the quality of the light transmitted, eliminates the glare



## STANDARD CUTTINGS

and increases the decorative appeal of the product by giving it a definite texture when laid up to form a glass masonry wall.

Each face cutting is designated by number. This number, when added to the series number, identifies the block both for size and cutting design. For instance, the  $4\frac{7}{8} \times 8$  in. block (series No. 1) with the face cutting pattern No. 11, would be identified as block No. 1-11. The  $5\frac{3}{4} \times 5\frac{3}{4}$  in. block (series No. 200) with face cutting pattern No. 11, would be identified as block No. 200-11.

**LIGHT TRANSMISSION**—Where the intensity of light to be admitted is the factor to be considered in the selection of glass blocks, a variety of face cuttings is offered. A choice can be made according to the light transmission percentages—making interior lighting controllable. The various face cuttings offer a wide range of transmission coefficients. Thus, too brilliant light can be controlled by the choice of a block having a suitably low transmission factor. Where all the light possible is required for interior vision, a wall built of blocks with Cutting No. 11 transmits 86.5% of the incident light. This value is comparable to the transmission value of ordinary windows which have an average coefficient of from 85% to 95%. The exterior faces of the blocks are either smooth or have simple ribs—to minimize the accumulation of surface dirt and to make its removal easy. This is important since the efficiency of any glass as a light-transmitting medium is seriously impaired by surface dirt.

**LIGHT DIFFUSION**—The light transmitted by Insulux Masonry is diffused perfectly. It is glareless and is comparable to the light from a northerly exposed window or skylight. The elimination of glare and shadows promotes efficiency, comfort and quality of workmanship. This light is particularly desirable for close work. Professor George Sherman of the Physics Department of Purdue University says, as a result of his tests, "When any of the cross-rib or pyramid-face blocks are held six inches from an intense light such as a high-power concentrated-filament lamp, no glare is observed when the block is viewed at any angle. In the single-rib blocks (No. 11 Cutting) only a very small glare is found under this very severe test. All blocks tested showed an excellent diffusion." An ever-changing decorative effect is produced by the play of light as the angle of vision changes.

**STANDARD CUTTINGS**—There are 4 standard cuttings. Cutting No. 11 consists of vertical ribs which are impressed upon the exterior faces of the block. The design of Cutting No. 1 consists of horizontal ribs on the inside of the 2 faces of the block and vertical ribs on the outside of the 2 faces of the block. Cutting No. 4 consists of very fine pyramidal prisms pressed onto the inside of the 2 faces of the block, the exterior being smooth. Slightly larger pyramidal prisms are pressed upon the inside of the 2 faces of the block to form Cutting No. 5, the exterior being smooth.

**SPECIAL STANDARDS**—A number of additional face cuttings are available at no increase in cost. These are designated as "Special Standards," of which the illustrations are representative. They are not regularly stocked in local warehouses but prompt shipment can be obtained from the factory at Muncie, Indiana. These Special Standard designs offer a further range of light transmission values and decorative possibilities. No. 7 Cutting has large vertical ribs on the inside of both faces, exterior faces smooth. Cutting No. 10 has small ribs vertically on one exterior face and horizontally on the other exterior face, the two interior faces being smooth. Cutting No. 2 has large ribs running on both faces. Cutting No. 3 is similar to Standard Cutting No. 4, except that a diamond pattern is created by small arrises running diagonally and at right angles to each other.

**SPECIAL BLOCKS**—The Owens-Illinois Glass Company will be pleased to consult with interested persons in the creation of glass masonry blocks for special conditions. Special face cuttings, colored blocks and blocks of special sizes can be produced. Information will be gladly furnished upon request.

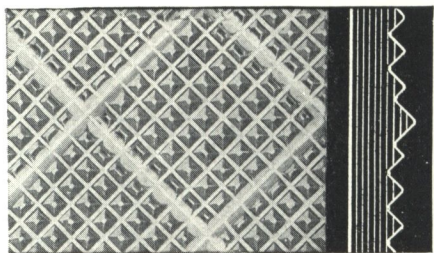

**CUTTING NO. 3.** Transmits 27.6% of the light falling upon it. 3.6 sq. ft. of this block are equivalent to 1 sq. ft. of ordinary window.

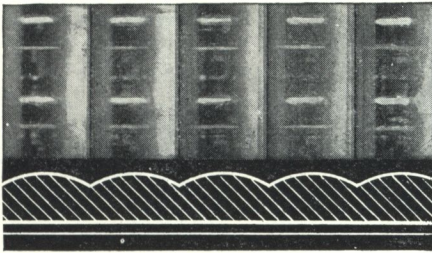

**CUTTING NO. 2.** Transmits 73.4% of the light falling upon it. 1.36 sq. ft. of this block are equivalent to 1 sq. ft. of ordinary window.

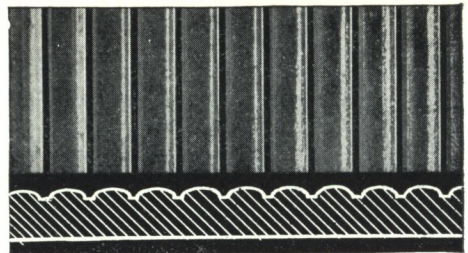

**CUTTING NO. 11.** Transmits 86.5% of the light falling upon it. 1.12 sq. ft. of this block are equivalent to 1 sq. ft. of ordinary window.

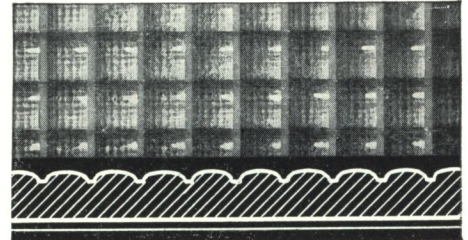

**CUTTING NO. 1.** Transmits 78.5% of the light falling upon it. 1.3 sq. ft. of this block are equivalent to 1 sq. ft. of ordinary window.

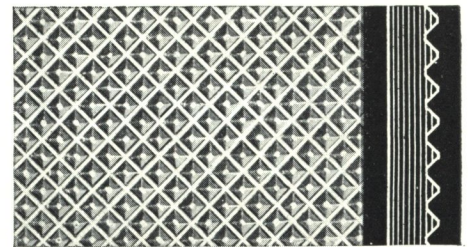

**CUTTING NO. 4.** Transmits 27.6% of the light falling upon it. 3.6 sq. ft. of this block are the equivalent of 1 sq. ft. of ordinary window.

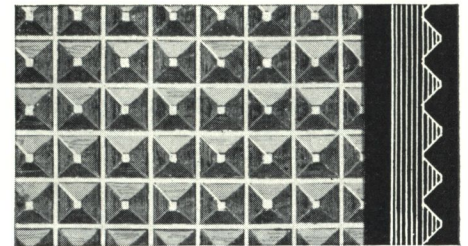

**CUTTING NO. 5.** Transmits 11.7% of the light falling upon it. 8.5 sq. ft. of this block are equivalent to 1 sq. ft. of ordinary window.

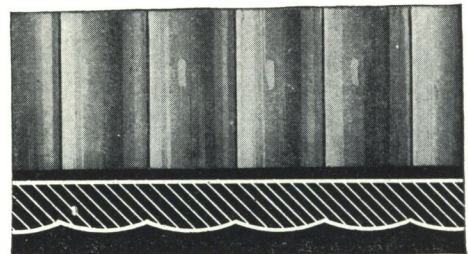

**CUTTING NO. 7.** Transmits 84.5% of the light falling upon it. 1.19 sq. ft. of this block are equivalent to 1 sq. ft. of ordinary window.

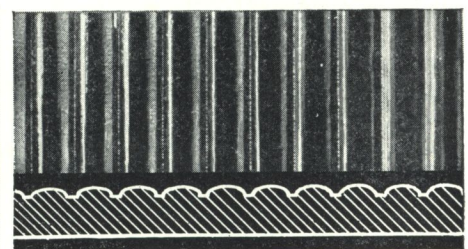

**CUTTING NO. 10.** Transmits 78.5% of the light falling upon it. 1.30 sq. ft. of this block are equivalent to 1 sq. ft. of ordinary window.



• **STRUCTURAL STRENGTH** • **RESISTANCE TO HEAT LOSS**

Owens-Illinois Glass Blocks are a pressed glass product which results in absolutely uniform wall thickness impossible to obtain by the blown process. The uniform wall thickness makes it possible to thoroughly anneal the blocks, thereby developing to the highest degree the natural mechanical strength of the material.

**COMPRESSIVE STRENGTH**—Insulux Glass Blocks are not now offered as a load-bearing material, yet they possess ample compressive strength to be self-supporting within the limits prescribed by the ratio of their thickness to any practical height. The average ultimate strength developed by this material in tests is 800 pounds per square inch with the standard ASTM cap. A safe working load for Insulux Glass Masonry erected in accordance with the specifications appearing on page 16 of this catalog, using a safety factor of 4, is 200 pounds per square inch.

**LATERAL STRENGTH**—Tests show that a panel 10 ft.-0 in. x 15 ft.-0 in. would withstand a 90 to 100 mile gale. Therefore, it will withstand the usual 20 pounds per square foot wind pressure allowance, with a safety factor of four.

**IMPACT STRENGTH**—The thickness of the shell wall of the block and its design make it withstand normal wall impact without failure.

**MORTAR BOND STRENGTH**—The standard requirement for mortar bond in brickwork is 13.8 pounds per square inch in tension. Tests on Insulux Glass Masonry show an average of 27.2 pounds per square inch. Similarly, they have proved equal in shear to many other masonry materials.

**THERMAL EXPANSION**—The expansion and contraction of Insulux Glass Blocks under temperature changes correspond closely with those of mortar in conjunction with which they are used.

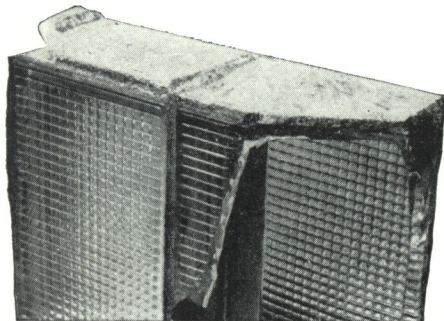

• The photograph illustrates the bond of the mortar and the special gritty surface coating with which the 4 mortar-bearing surfaces of the glass block are treated. This coating is water, alkali and acid resisting, insuring a high degree of bond between the mortar and the glass, and eliminating the likelihood of moisture penetration between the mortar joints and the blocks themselves.

The Building Code Committee of the Dept. of Commerce recommends the following working stresses in compression in lbs. per sq. in. They are presented here for comparison with Insulux Glass Masonry:

P. C. Concrete, 1:3:5.....	400
Brickwork, Lime and P.C. Mortar.....	130
Hollow Tile Blocks.....	80
Hollow Concrete Blocks.....	80
Rubble Stonework, P.C. Mortar.....	140
Insulux Translucent Masonry.....	200

The high resistance of Insulux Glass Masonry to heat loss by conduction or infiltration reduces the cost of air conditioning and artificial heating. It offers protection against penetration of solar heat. In the manufacturing process, the air in the hollow glass block is trapped at a very high temperature. When the block is cooled it contains only thoroughly dry air under partial vacuum, the rarefied dead air trapped in small volume forming an excellent heat insulator. Tests show Insulux Glass Block to be one of the best insulators among building materials, and unique when its light-transmitting properties are also considered.

**CONDUCTION**—Average coefficients of heat transmission in Btu's per hour per square foot per F° difference in temperature are based on a wind velocity of 15 mph. Coefficients for masonry walls marked \* are furred and have 3/4 in. plaster on metal lath.

3 7/8 in. Insulux Glass Masonry Wall.....	0.29
Single glazed window.....	1.13
Single glazed skylight.....	1.13
8 in. solid brick wall*.....	0.32
12 in. solid brick wall*.....	0.25
16 in. solid brick wall.....	0.25
Stuccoed 8 in. hollow tile wall*.....	0.27
Stuccoed 12 in. hollow tile wall*.....	0.22
16 in. concrete wall*.....	0.31
12 in. concrete wall*.....	0.32
4 in. hollow gypsum, plastered both sides...	0.27
4 in. hollow clay tile, plastered both sides...	0.40
2 in. solid plaster.....	0.53

**INFILTRATION**—Air infiltration through cracks around windows represents a considerable heat loss either in air conditioning or heating. Insulux Translucent Masonry used to admit light, because of the depth of its solid mortar joint, reduces this loss to a minimum. If openings must be used for natural ventilation, they can be much smaller in area and periphery.

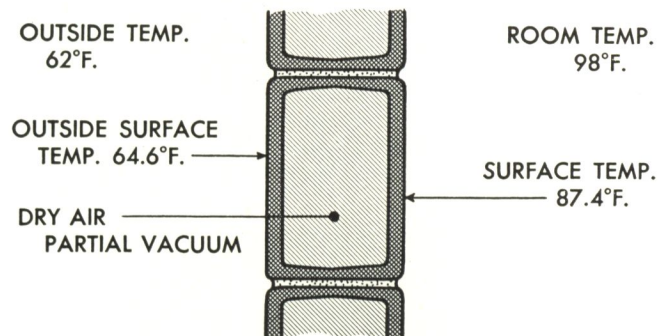

**SOLAR RADIATION**—It has been found that Insulux Translucent Masonry reduces the temperature due to direct sunlight of an enclosed space 25% to 40% as compared with an equal area of single glazed steel sash for the midday period of 4 hours. This is of paramount importance in relation to comfort and air conditioning.



A daylight view of the Owens-Illinois Building at the Century of Progress Exposition. Architect, Eloy Ruiz. This building was erected as an Exposition novelty, but nevertheless marked a definite phase in the development of glass masonry. Insulux Glass Blocks have been materially improved since this structure was built.



**SOUND DEADENING**—Minute vibrations are set up in partitions consisting of single thin sections of wood, glass or metal by the alternating pressure of the incident sound. The amount of transmission depends upon the mass or stiffness of the partition. Partitions constructed of Insulux Glass Masonry possess rigidity and thickness, making them effective in deadening the transmission of sound.

**FIRE RESISTANCE**—In order to form an effective fire stop to fires of the usual duration and intensity, it is necessary to prevent the passage of flame through any material. Incidental crazing and cracking, however severe, does not destroy the value of the material as a fire stop. The cooling and impact of fire streams may cause cracks and crazing but do not result in failure of the Insulux Glass Masonry wall under conditions encountered with proper fire protection.

**MOISTURE PENETRATION**—Moisture can penetrate an Insulux Glass Masonry wall only through the mortar joints which, with the mortars specified, is practically impossible. Neither under test nor in actual use has condensation collected on the inside surface of an Insulux Glass Masonry wall within practical ranges of temperature, humidity and air motion.

**CLEANLINESS AND MAINTENANCE**—Insulux Glass Masonry has the high sanitary property that is inherent in glass. The surface of glass is non-porous which prevents the passage of air and gases and will not absorb odors, water or grease. Several of the face cutting designs of Insulux Glass Blocks have smooth exterior faces, the prismatic cutting being impressed upon the interior of the faces of the block. In other

European architects have long been familiar with glass block construction. This kaffeehaus by architect Bohuslav Fuchs illustrates a striking combination of its functional and decorative use.

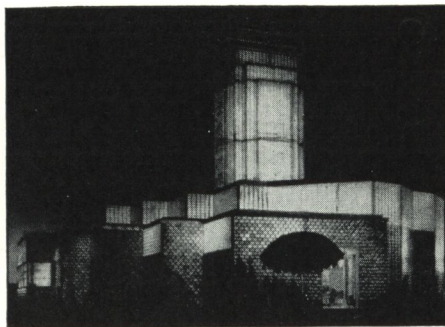
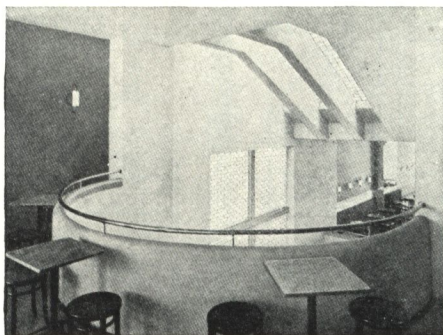

The lighting of this building made it as beautiful by night as by day. Built entirely of glass block, it withstood the extremely rigorous weather conditions of the Chicago lake front, attesting to the practicality of glass masonry construction.

designs the faces have simple, flat, rounded ribs on their exteriors. The simplicity of the surfaces thus obtained minimizes the accumulation of surface dirt and makes its removal easy. The use of glass masonry eliminates air infiltration which is often a path by which dirt and dust enter a building. The hard brilliant surface of glass blocks does not disintegrate and cannot be easily marked, written upon or defaced. The weather does not affect glass masonry, it does not oxidize; it requires no painting nor other interior finish.

**REMOVAL AND REPLACEMENT**—A damaged glass block can be removed easily from the wall by drilling holes in the mortar joint in opposite corners and then inserting a keyhole saw through the joint and sawing out the block. The new block is then buttered with mortar, inserted in place and the job completed by pointing.

**USES OF INSULUX MASONRY**—Since Insulux Translucent Masonry admits diffused light of desirable character without allowing heat flow, it offers an economy in the construction of air-conditioned and artificially heated buildings obtainable in no other building material. The sanitary properties make glass masonry desirable for use in such buildings as hospitals, dairies, bakeries and breweries. The water-clear glass may be floodlighted to produce striking and easily varied decorative effects. The diffused characteristics definitely indicate its use in public schools, shops, offices, or any place where close work is the daily routine and shadows are undesirable. An infinite number of applications will suggest themselves to designers and builders far beyond the scope of any tabulation that might be attempted.

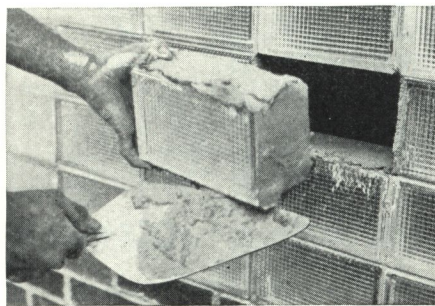

No special skill is required in removing and replacing glass blocks. The buttered block is easily replaced and pointing the joint completes the job.



Below are shown various details for openings through Insulux Masonry walls. Doors, windows, louvers or other openings can be made as easily as with other types of masonry. Any type of frame or trim is easily installed. The frames for openings, with their anchors bent at 90°, should be put in place first and the glass masonry built to them. The size of frames for openings should be adjusted to the course heights of the blocks to be used since blocks cannot be chipped to fit uneven spaces. Different methods of anchoring large panels of translucent masonry to intermediate supports are illustrated.

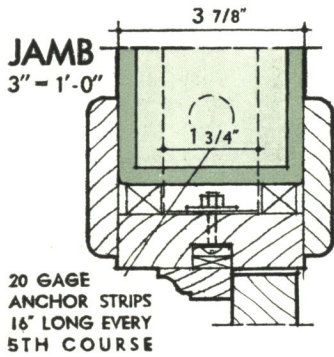

**WOOD DOOR FRAME**

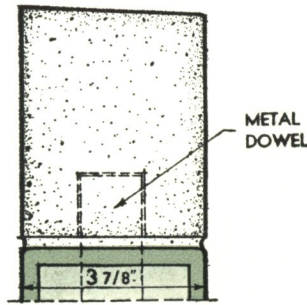

**STONE COPING**

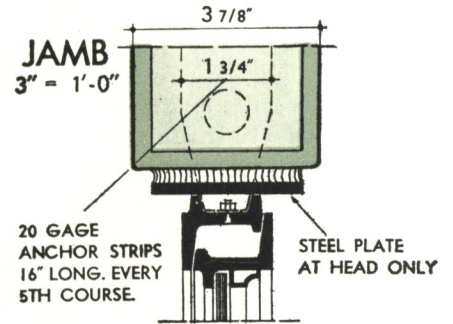

**STEEL CASEMENT DOOR**

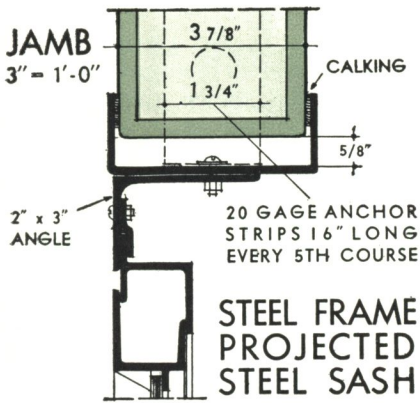

**STEEL FRAME  
PROJECTED  
STEEL SASH**

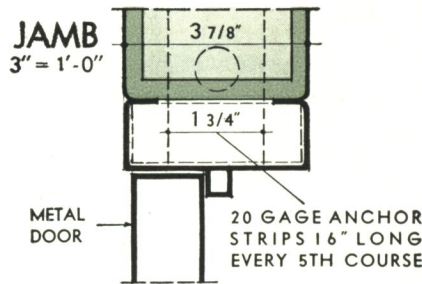

**PRESSED STEEL FRAME  
FOR INTERIOR DOOR**

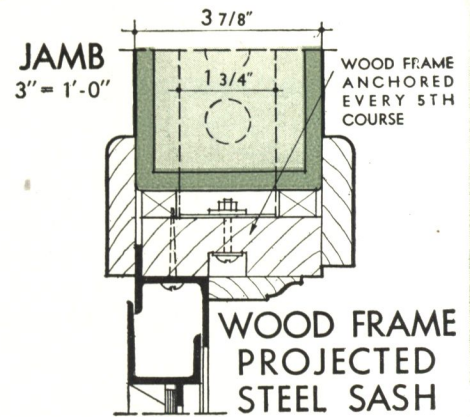

**WOOD FRAME  
PROJECTED  
STEEL SASH**

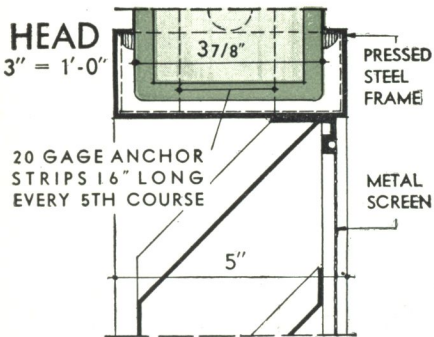

**METAL LOUVER**

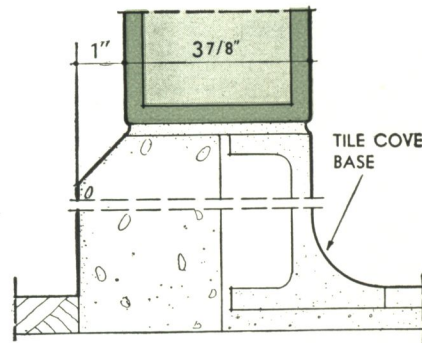

**CONCRETE & TILE BASE**

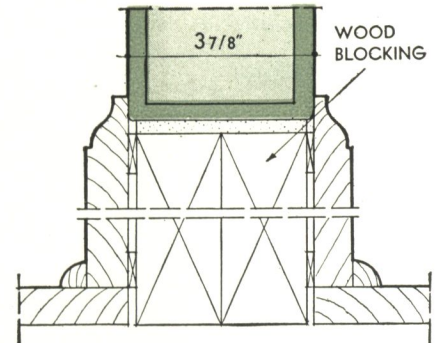

**WOOD BASE**



# TYPICAL DETAILS OF INSULUX CONSTRUCTION

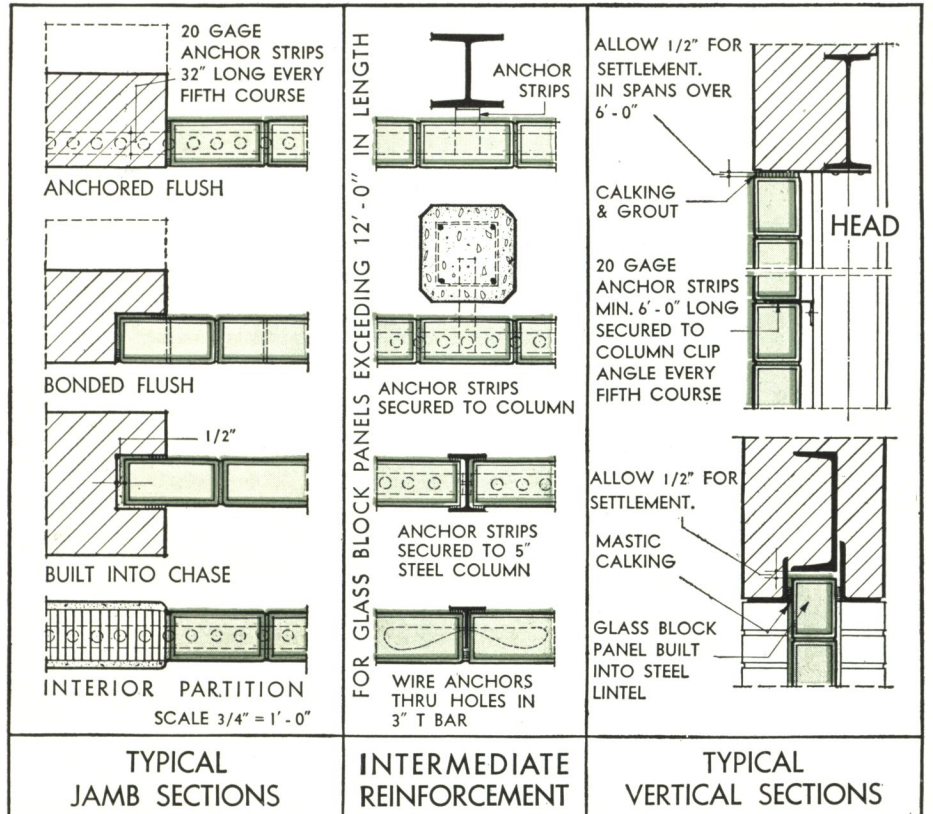
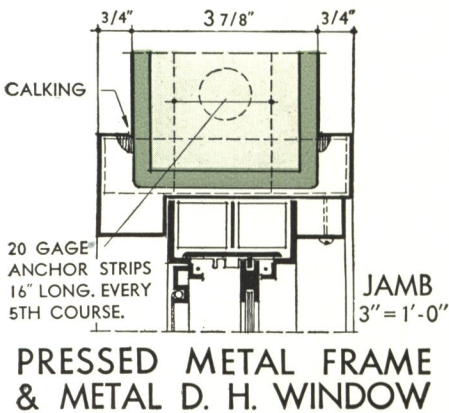
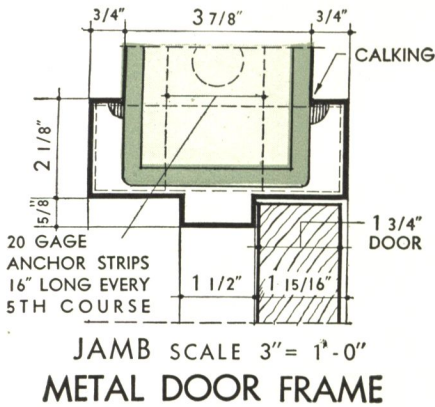

## REINFORCING & ANCHORING PANELS IN MASONRY WALLS

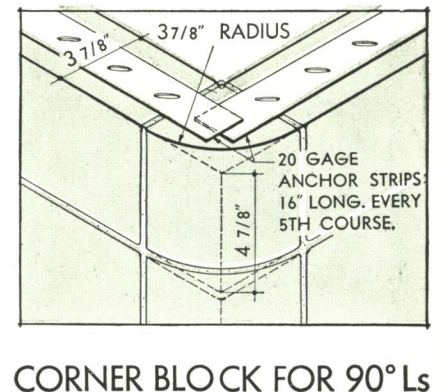
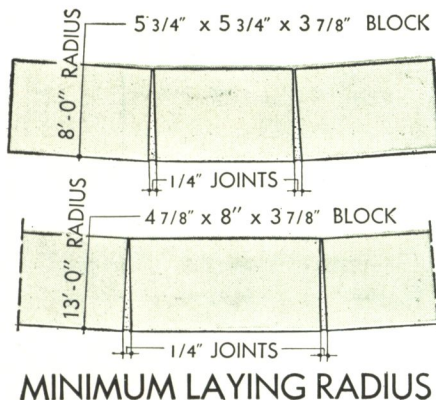
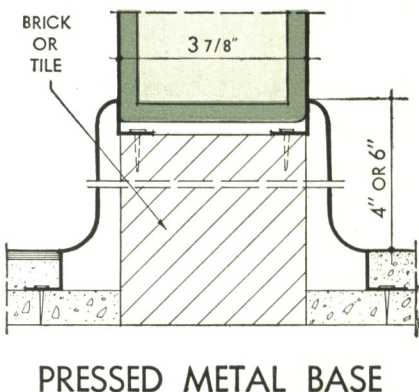



● Insulux Glass Blocks offer many possibilities for patterns, either used alone or combined with ordinary brickwork or other masonry. In Figure 1, the half block has been combined with the rectangular block. Figure 2 is ordinary Running Bond. Figure 3 shows the glass block bonded into a brick masonry wall by means of quoins. The Checkerboard Bond shown in Figure 4 can be varied by the selection of different face cuttings. Figure 7 illustrates the use of the half blocks by means of which almost any brick bond pattern can be rendered in glass masonry. Figure 9 shows Spiral Bond which requires a chase at the jambs to cover the start of the pattern.

DIMENSIONS OF INSULUX GLASS MASONRY

Number of Units	47/8" x 8"				5 3/4" x 5 3/4"		7 3/4" x 7 3/4"	
	Height		Width		Height or Width		Height or Width	
	1/4" joints	3/16" joints	1/4" joints	3/16" joints	1/4" joints	3/16" joints	1/4" joints	3/16" joints
1	5 1/8"	5 1/16"	8 1/4"	8 3/16"	6"	5 15/16"	8"	7 15/16"
2	10 1/4"	10 1/8"	1' - 4 1/2"	1' - 4 3/8"	1' - 0"	11 7/8"	1' - 4"	1' - 3 7/8"
3	1' - 3 3/8"	1' - 3 3/16"	2' - 0 3/4"	2' - 0 9/16"	1' - 6"	1' - 5 13/16"	2' - 0"	1' - 11 13/16"
4	1' - 8 1/2"	1' - 8 1/4"	2' - 9"	2' - 8 3/4"	2' - 0"	1' - 11 3/4"	2' - 8"	2' - 7 3/4"
5	2' - 1 5/8"	2' - 1 5/16"	3' - 5 1/4"	3' - 4 15/16"	2' - 6"	2' - 5 11/16"	3' - 4"	3' - 3 11/16"
6	2' - 6 3/4"	2' - 6 3/8"	4' - 1 1/2"	4' - 1 1/8"	3' - 0"	2' - 11 5/8"	4' - 0"	3' - 11 5/8"
7	2' - 11 7/8"	2' - 11 7/16"	4' - 9 3/4"	4' - 9 5/16"	3' - 6"	3' - 5 9/16"	4' - 8"	4' - 7 9/16"
8	3' - 5"	3' - 4 1/2"	5' - 6"	5' - 5 1/2"	4' - 0"	3' - 11 1/2"	5' - 4"	5' - 3 1/2"
9	3' - 10 1/8"	3' - 9 9/16"	6' - 2 1/4"	6' - 1 11/16"	4' - 6"	4' - 5 7/16"	6' - 0"	5' - 11 7/16"
10	4' - 3 1/4"	4' - 2 5/8"	6' - 10 1/2"	6' - 9 7/8"	5' - 0"	4' - 11 3/8"	6' - 8"	6' - 7 3/8"
11	4' - 8 3/8"	4' - 7 11/16"	7' - 6 3/4"	7' - 6 1/16"	5' - 6"	5' - 5 5/16"	7' - 4"	7' - 3 5/16"
12	5' - 1 1/2"	5' - 0 3/4"	8' - 3"	8' - 2 1/4"	6' - 0"	5' - 11 1/4"	8' - 0"	7' - 11 1/4"
13	5' - 6 5/8"	5' - 5 13/16"	8' - 11 1/4"	8' - 10 7/16"	6' - 6"	6' - 5 3/16"	8' - 8"	8' - 7 3/16"
14	5' - 11 3/4"	5' - 10 7/8"	9' - 7 1/2"	9' - 6 5/8"	7' - 0"	6' - 11 1/8"	9' - 4"	9' - 3 1/8"
15	6' - 4 7/8"	6' - 3 15/16"	10' - 3 3/4"	10' - 2 13/16"	7' - 6"	7' - 5 1/16"	10' - 0"	9' - 11 1/16"
16	6' - 10"	6' - 9"	11' - 0"	10' - 11"	8' - 0"	7' - 11"	10' - 8"	10' - 7"
17	7' - 3 1/8"	7' - 2 1/16"	11' - 8 1/4"	11' - 7 3/16"	8' - 6"	8' - 4 15/16"	11' - 4"	11' - 2 15/16"
18	7' - 8 1/4"	7' - 7 1/8"	12' - 4 1/2"	12' - 3 3/8"	9' - 0"	8' - 10 7/8"	12' - 0"	11' - 10 7/8"
19	8' - 1 3/8"	8' - 0 3/16"	13' - 0 3/4"	12' - 11 9/16"	9' - 6"	9' - 4 13/16"	12' - 8"	12' - 6 13/16"
20	8' - 6 1/2"	8' - 5 1/4"	13' - 9"	13' - 7 3/4"	10' - 0"	9' - 10 3/4"	13' - 4"	13' - 2 3/4"
21	8' - 11 5/8"	8' - 10 5/16"	14' - 5 1/4"	14' - 3 15/16"	10' - 6"	10' - 4 11/16"	14' - 0"	13' - 10 11/16"
22	9' - 4 3/4"	9' - 3 3/8"	15' - 1 1/2"	15' - 0 1/8"	11' - 0"	10' - 10 5/8"	14' - 8"	14' - 6 5/8"
23	9' - 9 7/8"	9' - 8 7/16"	15' - 9 3/4"	15' - 8 5/16"	11' - 6"	11' - 4 9/16"	15' - 4"	15' - 2 9/16"
24	10' - 3"	10' - 1 1/2"	16' - 6"	16' - 4 1/2"	12' - 0"	11' - 10 1/2"	16' - 0"	15' - 10 1/2"
25	10' - 8 1/8"	10' - 6 9/16"	17' - 2 1/4"	17' - 0 11/16"	12' - 6"	12' - 4 7/16"	16' - 8"	16' - 6 7/16"
26	11' - 1 1/4"	10' - 11 5/8"	17' - 10 1/2"	17' - 8 7/8"	13' - 0"	12' - 10 3/8"	17' - 4"	17' - 2 3/8"
27	11' - 6 3/8"	11' - 4 11/16"	18' - 6 3/4"	18' - 5 1/16"	13' - 6"	13' - 4 5/16"	18' - 0"	17' - 10 5/16"
28	11' - 11 1/2"	11' - 9 3/4"	19' - 3"	19' - 1 1/4"	14' - 0"	13' - 10 1/4"	18' - 8"	18' - 6 1/4"
29	12' - 4 5/8"	12' - 2 13/16"	19' - 11 1/4"	19' - 9 7/16"	14' - 6"	14' - 4 3/16"	19' - 4"	19' - 2 3/16"
30	12' - 9 3/4"	12' - 7 7/8"	20' - 7 1/2"	20' - 5 5/8"	15' - 0"	14' - 10 1/8"	20' - 0"	19' - 10 1/8"
31	13' - 2 7/8"	13' - 0 15/16"	21' - 3 3/4"	21' - 1 13/16"	15' - 6"	15' - 4 1/16"	20' - 8"	20' - 6 1/16"
32	13' - 8"	13' - 6"	22' - 0"	21' - 10"	16' - 0"	15' - 10"	21' - 4"	21' - 2"
33	14' - 1 1/8"	13' - 11 1/16"	22' - 8 1/4"	22' - 6 3/16"	16' - 6"	16' - 3 15/16"	22' - 0"	21' - 9 15/16"
34	14' - 6 1/4"	14' - 4 1/8"	23' - 4 1/2"	23' - 2 3/8"	17' - 0"	16' - 9 7/8"	22' - 8"	22' - 5 7/8"



# GLASS MASONRY BOND PATTERNS

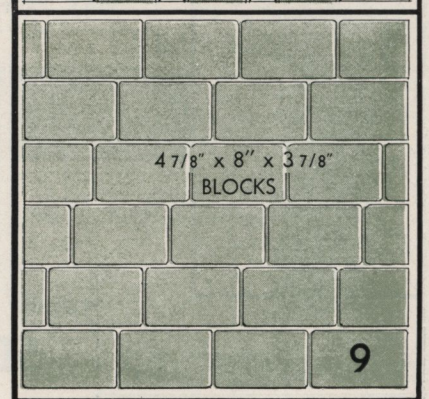
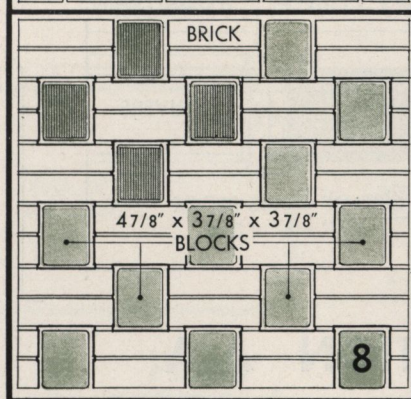
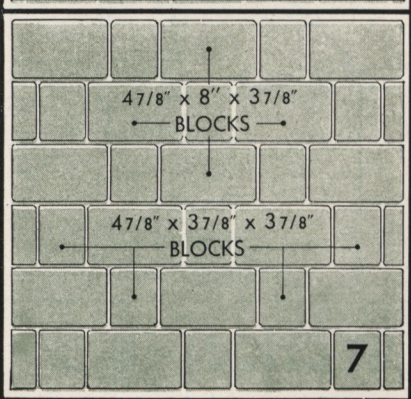
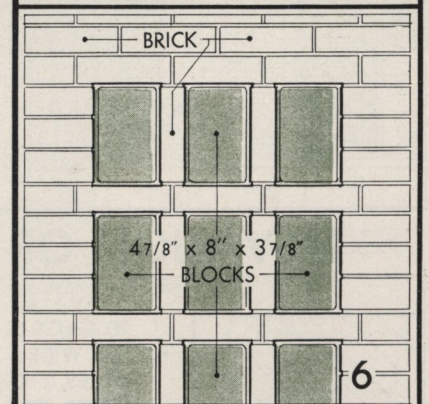
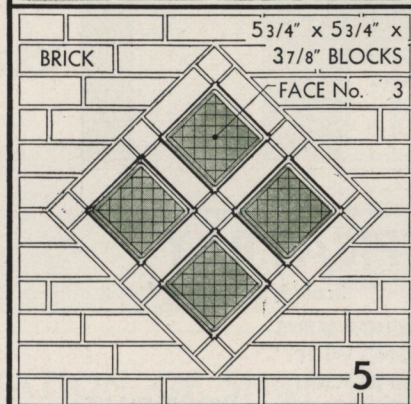
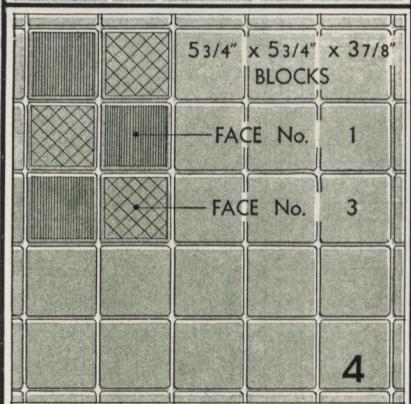
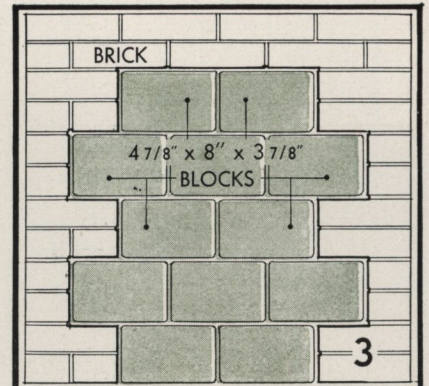
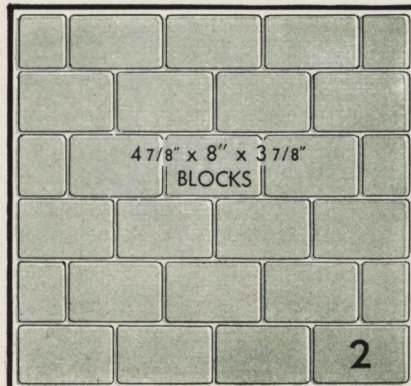
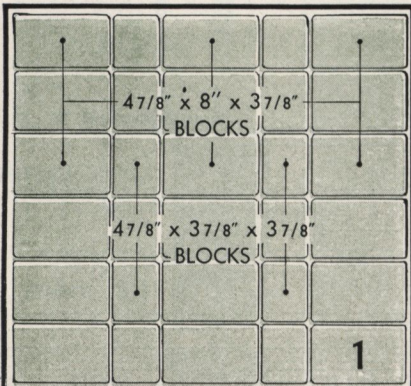



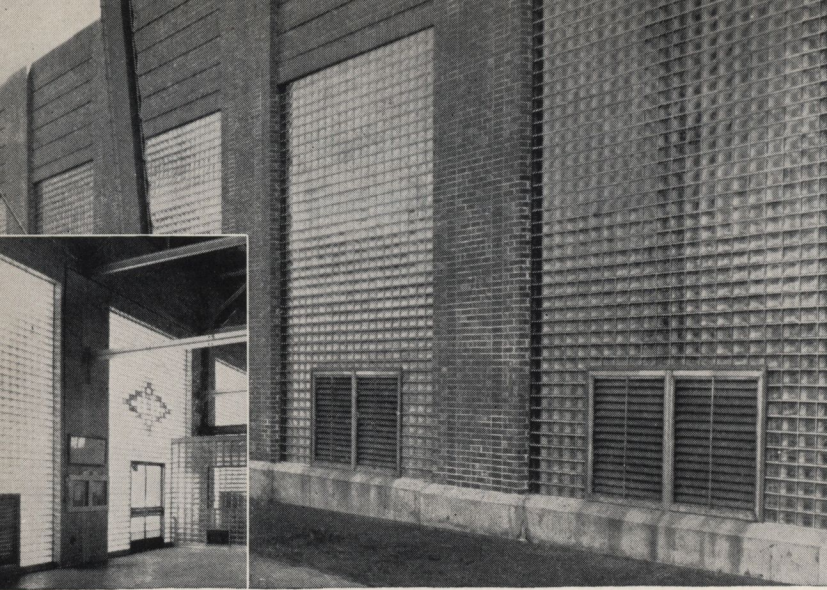

## MODERNIZATION OF INDUSTRIAL BUILDINGS

The obsolescence of industrial buildings is in many cases no less than that of the machinery and equipment which they house. With the increase in efficiency brought by modern air-conditioning methods, the heat loss of large windows becomes a critical item of expense. The use of Insulux Translucent Masonry provides perfectly diffused lighting and reduces the cost of heating during the cold months and air conditioning during the summer.

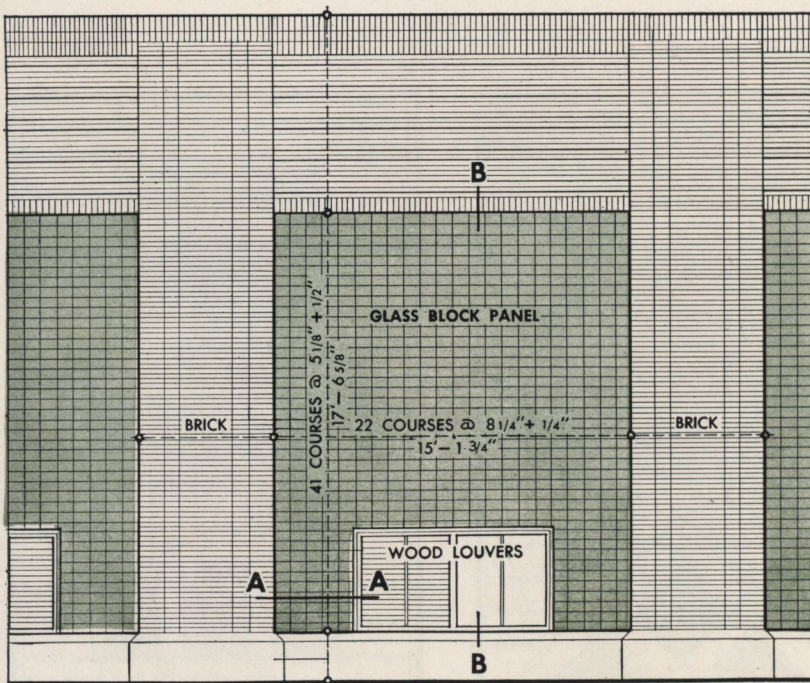

### ELEVATION OF TYPICAL BAY

Scale  $\frac{1}{8}'' = 1' - 0''$

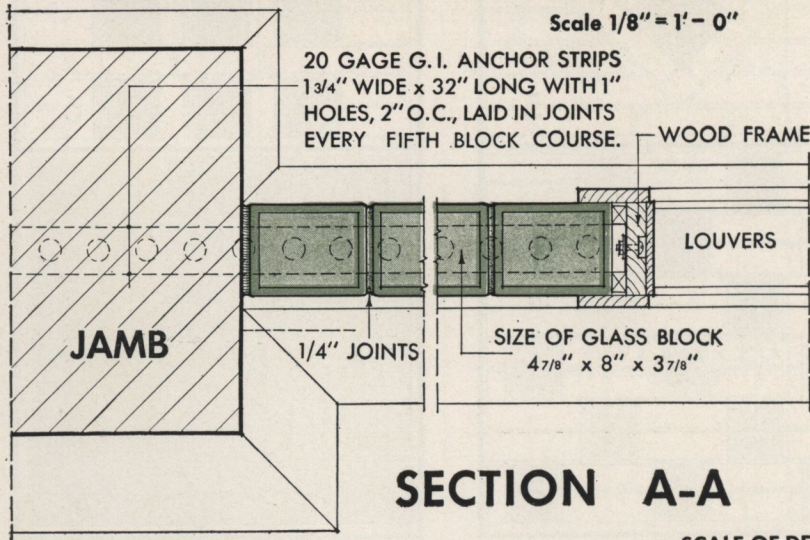

### SECTION A-A

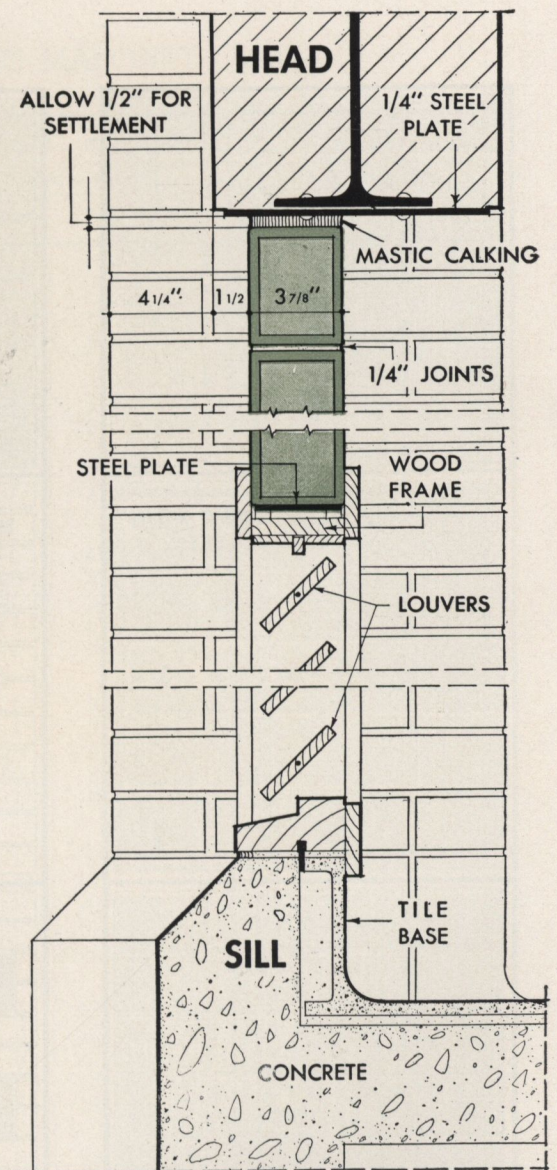

### SECTION B-B

SCALE OF DETAILS:  $\frac{1}{2}'' = 1' - 0''$



# STORE FRONT DESIGN IN INSULUX BLOCK

In the design shown on this page, advantage has been taken of both the functional and the decorative properties of the material. The glass bulkhead and spandrel admit light into the building during the daylight hours, or can be floodlighted from the inside to increase the "eye appeal" of the front. Colored floodlighting at night turns the store front into a compelling advertisement. The use of water-clear blocks permits great flexibility in the color scheme. A simple change in the lamps or screens used in the artificial lighting results in an entirely new effect whenever desired.

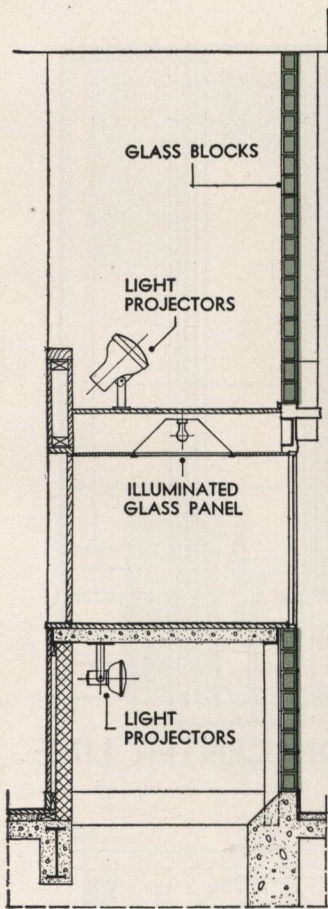
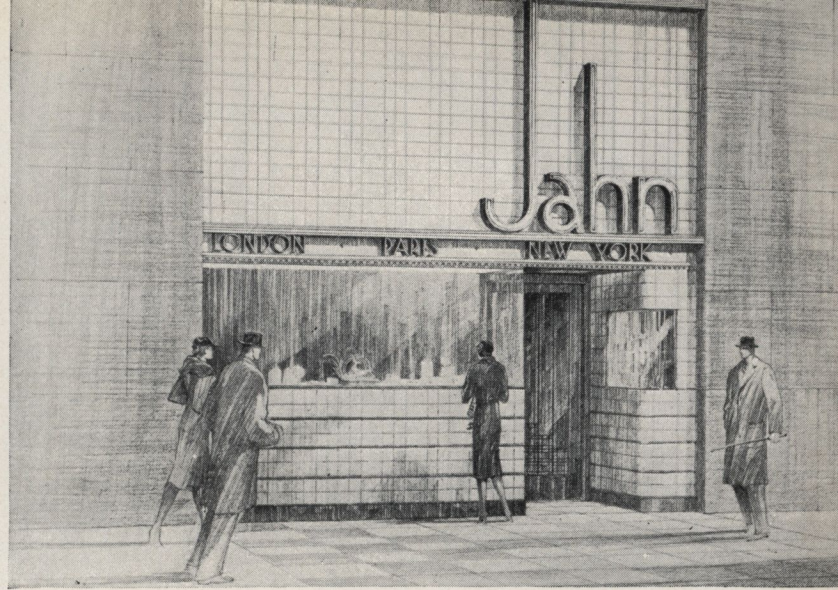

**SECTION**  
SCALE 1/4" = 1'-0"

20 GAGE ANCHOR STRIPS — 1 3/4" WIDE EVERY 5th COURSE

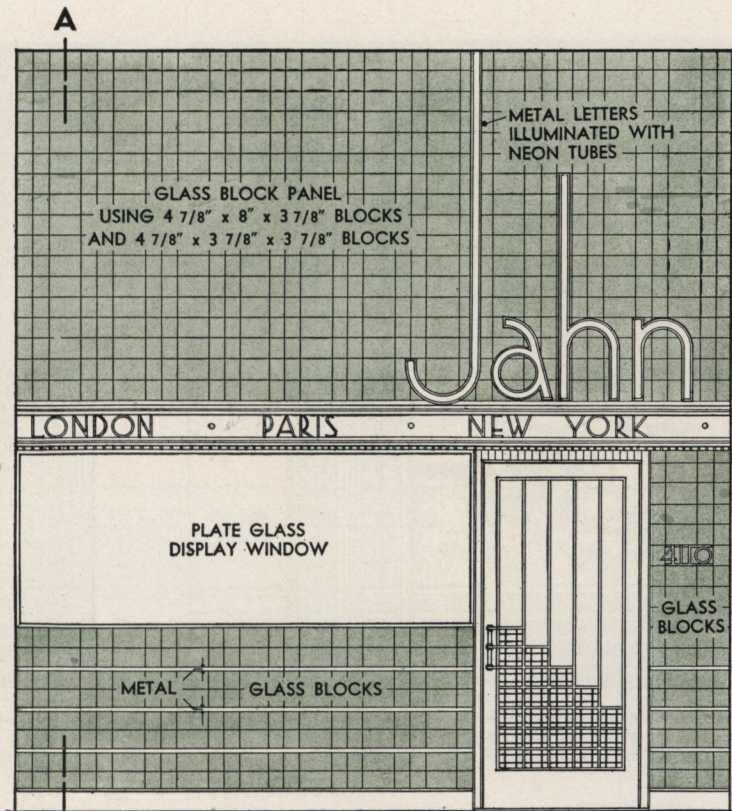

**ELEVATION OF SHOP FRONT**

SCALE 1/4" = 1'-0"

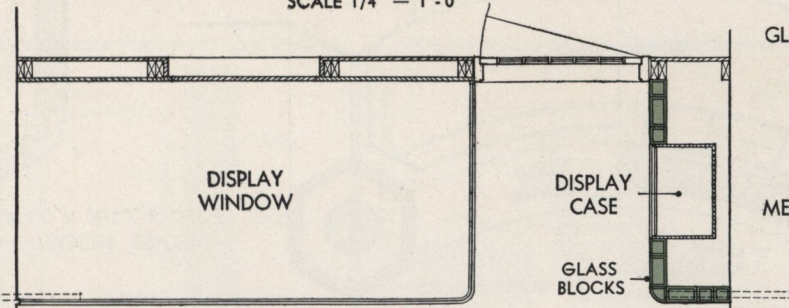

**PLAN**  
SCALE 1/4" = 1'-0"

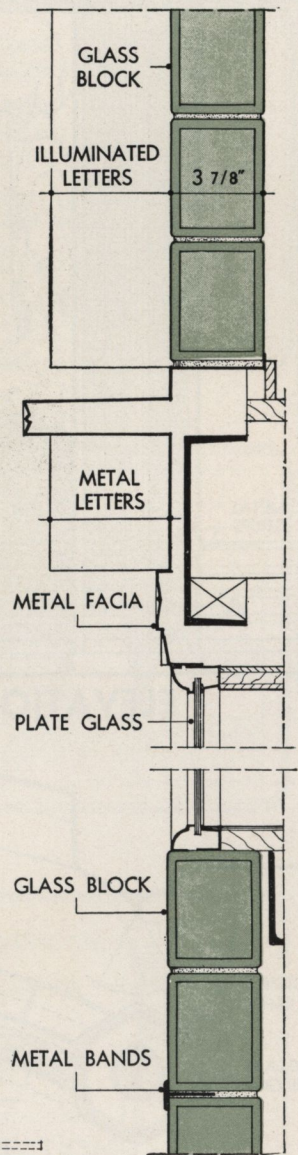

**SECTION A-A**  
SCALE 1 1/2" = 1'-0"



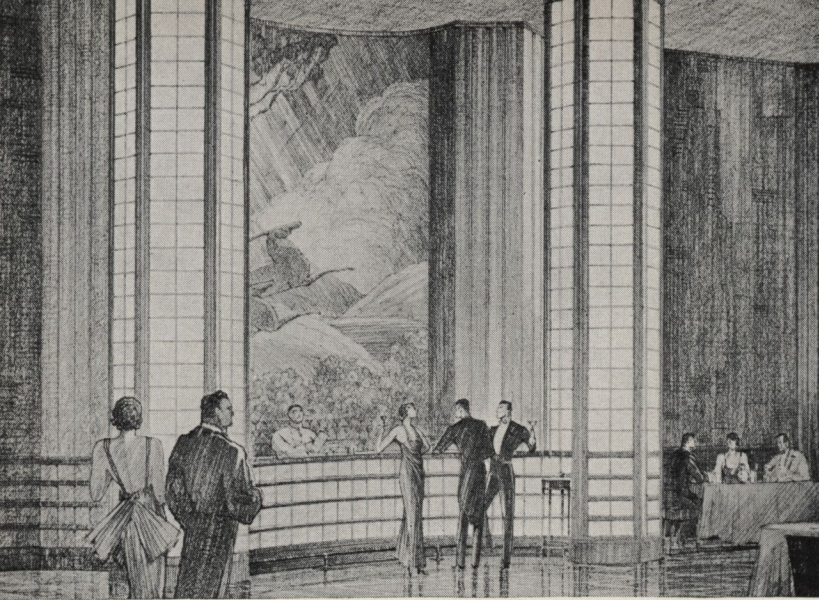

## INSULUX BLOCK FOR MODERN INTERIORS

The imagination of the creative designer is allowed full play with Insulux Translucent Masonry. The sparkling surface and the possibility of striking color effects by means of artificial lighting mark a new step in the development of the modern architectural treatment of interiors. Reference to the plan of the columns suggests one method of lighting. The encasing around the structural column is painted white to reflect the light and create an even tone of illumination. The metal corners containing the strip lighting are removable for the replacement of lamps. The glass face of the bar is lighted by a series of small reflectors, as shown in the section.

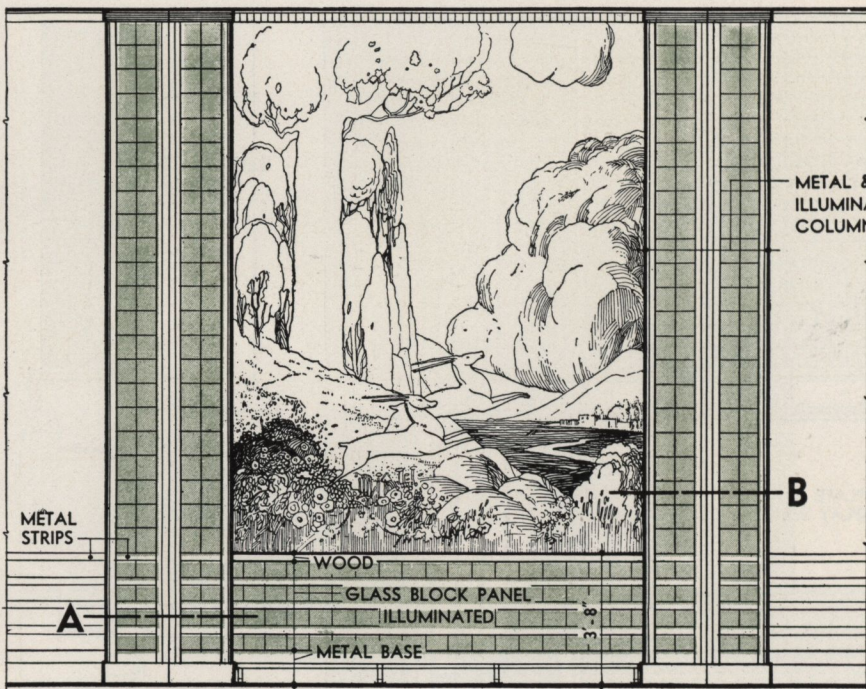

ELEVATION OF DECORATIVE BAR

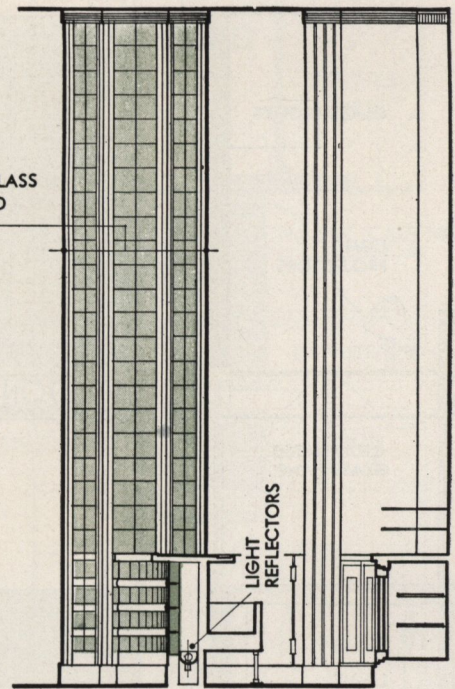

SECTION ON CENTER LINE

SCALE 3/16" = 1'-0"

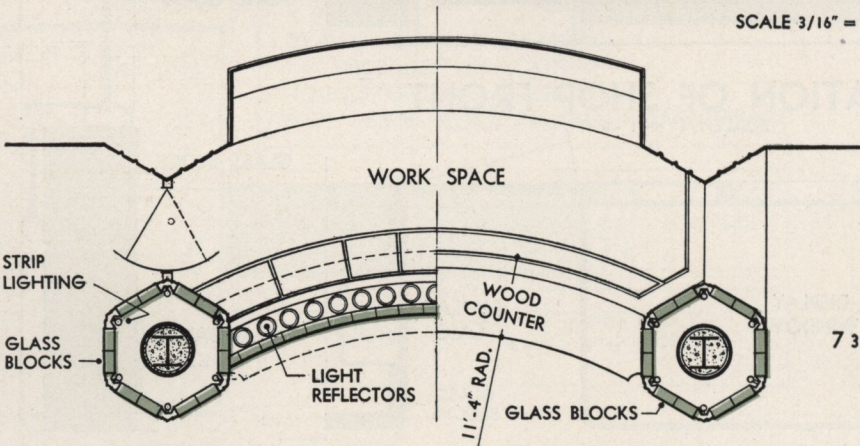

PLAN AT A

PLAN AT B

SCALE 3/16" = 1'-0"

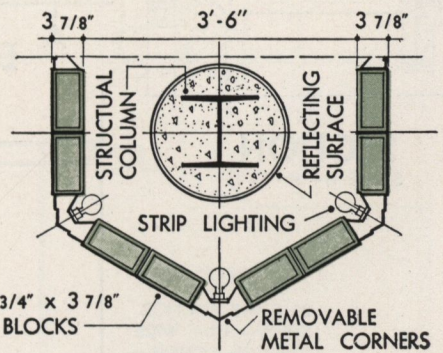

DETAIL OF ILLUMINATED COLUMN

SCALE 1/2" = 1'-0"



# INTERIOR PARTITIONS OF INSULUX MASONRY

Insulux Glass Masonry offers many advantages over other materials in the construction of interior partitions. Office corridor partitions can be made highly resistant to sound transmission and attractive in appearance, as shown in Figures 1, 2 and 3. The high sanitary property of Insulux Glass Block and its lack of porosity makes it an ideal material for shower enclosures, hospital and food factory construction. In industrial and loft buildings, it is ideal for dividing spaces without the loss of light, as suggested in Figure 5. The decorative quality of Insulux Glass Block makes it a suitable material for many other uses, one of which is suggested in Figure 6.

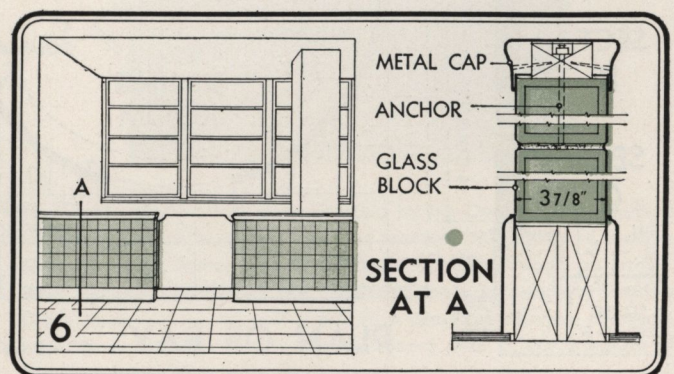
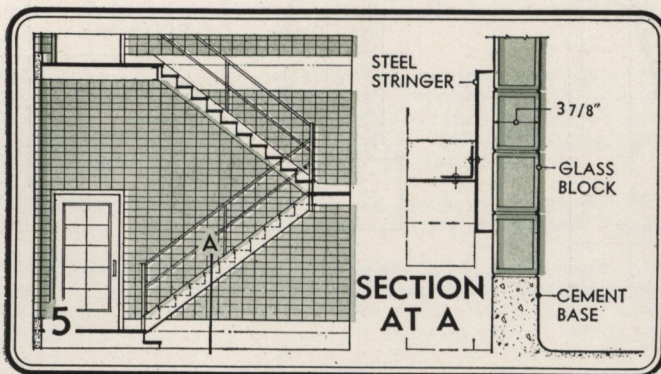
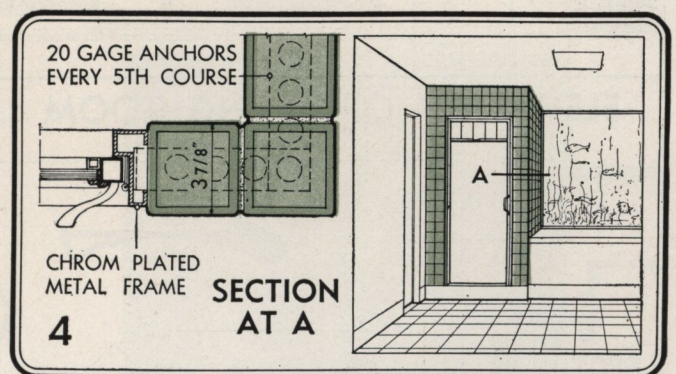
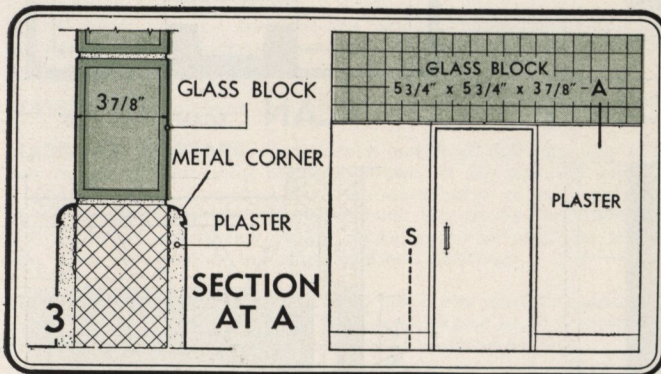
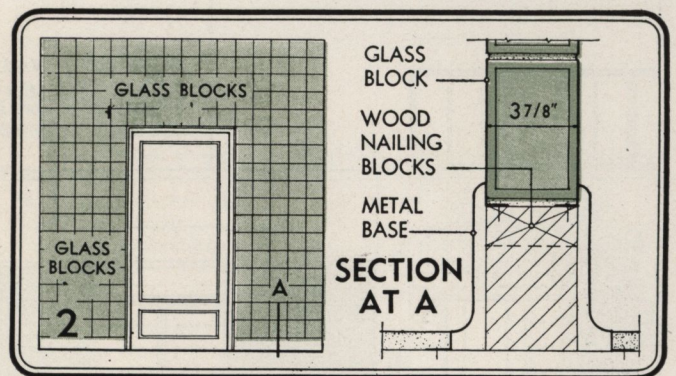
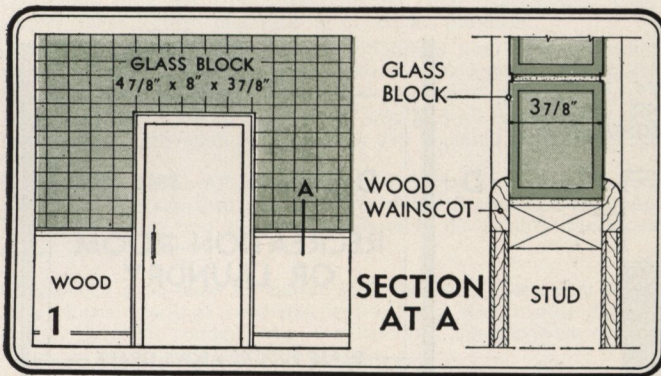
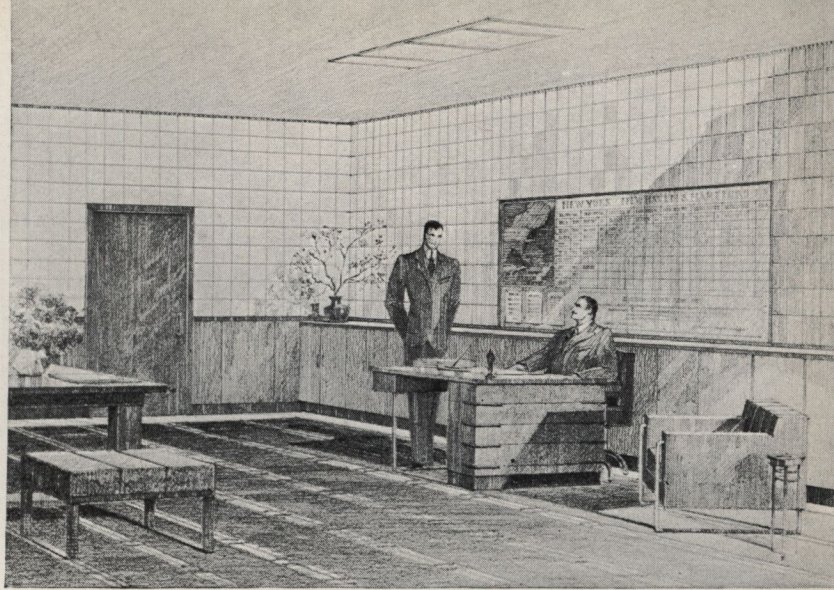



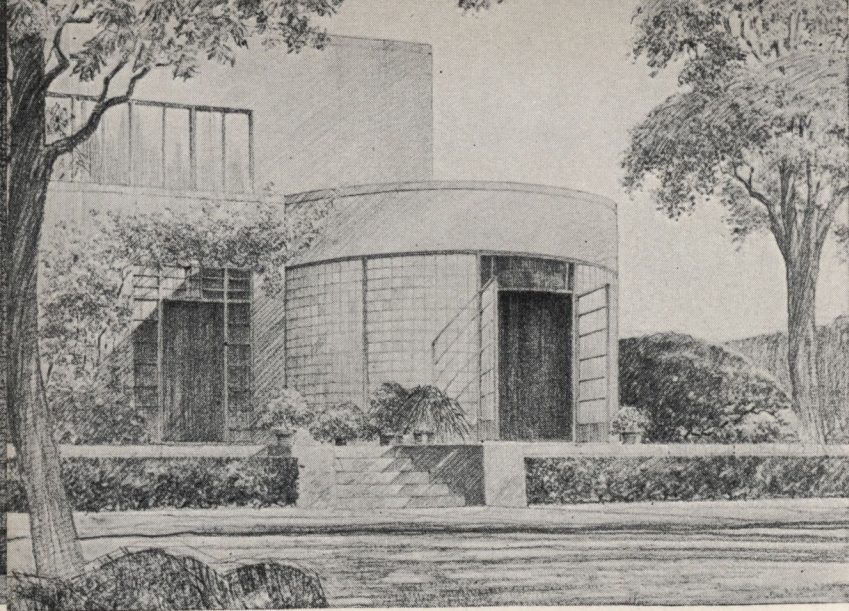

## INSULUX MASONRY FOR RESIDENCES

On this page are suggested two uses for Insulux Glass Masonry, but many others will occur to the designer. The ability to admit light of pleasing quality while obscuring the vision of outsiders makes it adaptable to uses such as are indicated here. Openings overlooking unpleasant surroundings may be made to admit light, at the same time obscuring an unsightly view. The problem of securing adequate light in bathrooms without sacrificing privacy is one easily solved with Insulux Translucent Masonry. Basement laundries and recreation rooms can be well lighted by Insulux bulkheads, as shown in the drawing at the lower right.

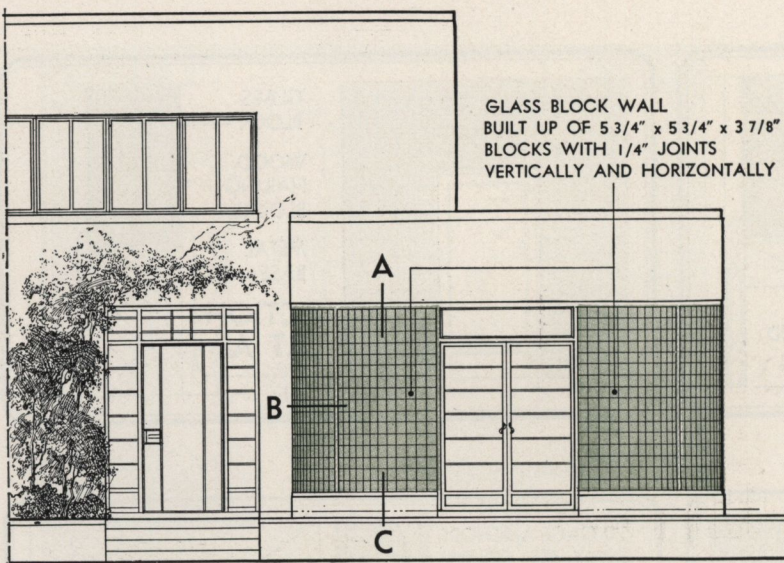

**ELEVATION OF DINING ROOM** SCALE 1/8" = 1'-0"

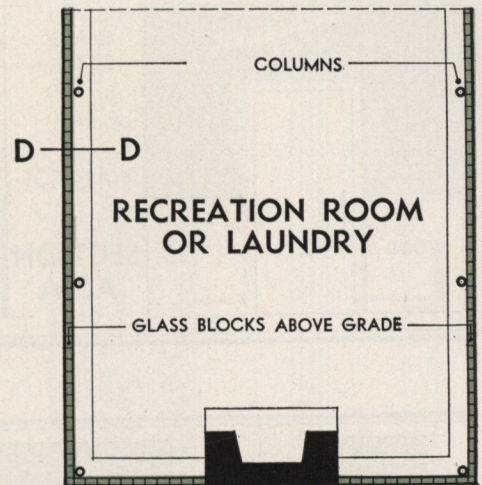

**PLAN** SCALE 1/8" = 1'-0"

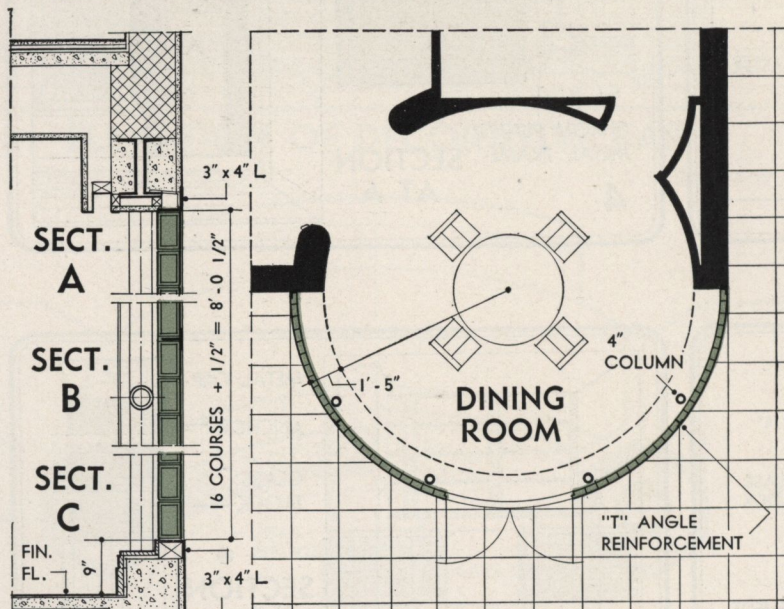

**PLAN OF BAY** SCALE 1/8" = 1'-0"

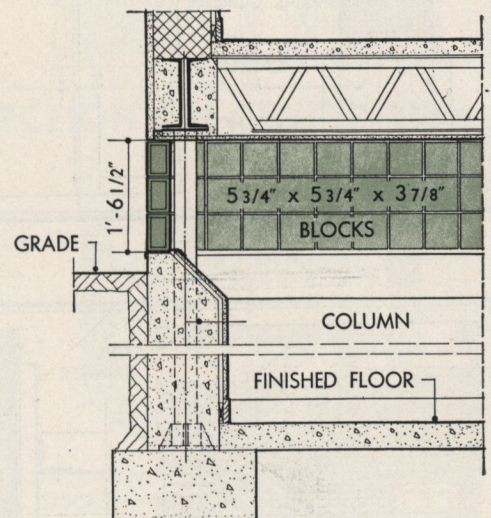

**SECTION D-D** SCALE 3/8" = 1'-0"



## BASIC SPECIFICATIONS

**GLASS BLOCK**—Where glass block are shown on drawings or called for in these specifications, they shall be Insulux Glass Block as manufactured by the Owens-Illinois Glass Company.

**SIZE AND CUTTING**—All Insulux Glass Block shall be of size and cutting design as shown on drawings (or) shall be of the following sizes and cutting designs (here list the location, sizes and cutting design numbers.)

**CEMENT**—All cement used in mortar shall be a portland cement complying with the specifications of the American Society for Testing Materials.

**LIME**—All lime used for mortar may be either quicklime or hydrated lime.

Quicklime shall be fresh, well burned, free from ashes, core, clinker, other foreign materials or air-slaked particles.

Quicklime shall be slaked in a water-tight box using sufficient water to prevent burning and to make a creamy putty. During the slaking it shall be thoroughly hoed to prevent burning.

All slaked lime shall be aged for at least 7 days before using and the resultant putty shall be sufficiently stiff to permit easy shoveling.

**HYDRATED LIME**—All hydrated lime shall be of standard brand, shall meet the standard specifications of the American Society for Testing Materials and shall be delivered in the original packages of the manufacturer.

**SAND**—All sand used for mortar shall be clean, sharp with angular particles, free from vegetable matter, loam, clay or other foreign matter. It shall comply with the standard specifications of the American Society for Testing Materials.

**MORTAR COLORS**—All mortar colors shall be mineral colors of standard brand and shall be delivered to the job in the original packages of the manufacturer.

Mortar colors may be paste or dry powder, chemically inert and alkaline proof. All mortar colors shall be used according to manufacturer's directions.

**WATER**—Shall be clean, free from alkalis or organic matter.

**MASONRY MORTARS**—A masonry mortar of high strength and low volume change may be used instead of the portland cement and lime mixture, if desired. Any standard brand of masonry mortar, of which there are several meeting the above requirements, will be found satisfactory. Such masonry mortar shall be mixed and used according to the manufacturer's directions.

**MORTAR**—Materials used in making the mortar shall be measured by volume. For this purpose 25 pounds quicklime or 40 pounds hydrated lime shall equal one cubic foot of portland cement.

All mortars shall be composed of one part portland cement, one part lime and four parts sand. If conditions warrant it, sand can be altered to use as high as five parts. It shall be mixed in a watertight box and hoed from end to end until thoroughly incorporated. Consistency shall be such that the hoe is clean when withdrawn from the mortar.

**LAYING**—Fill all joints uniformly and completely and allow the mortar to set after each five courses. Compress or point joints on both surfaces with metal pointing tool. Tool when set. If block must be disturbed after laid, clean it and relay. All openings must have steel lintels except those spanned by an Insulux unit.

**CALKING**—Where called for by the details, use a plastic, non-hardening, water-repellant calking compound of approved brand.

**REINFORCEMENT**—Use 20 gauge x 1 3/4 in. x 6 ft. strips with 1 in. diameter perforations, 1 3/4 in. OC galvanized after shearing. Place reinforcing strips in all glass masonry panels over 6 ft. 0 in. wide, every fifth course. Lap strings 8 in. allowing ends to act as anchors to the masonry piers by projecting into the masonry at least 18 in.

### SCIENTIFIC TEST DATA

Technical data are available as the result of extensive laboratory tests on many of the aspects of translucent-masonry construction. Additional information on scientific questions will be furnished gladly upon request.

### COST OF INSULUX MASONRY

It is only by the Owens-Illinois method of manufacturing glass blocks that a product of great uniformity can be produced at low cost. Insulux Glass Masonry compares in first cost with medium quality 8 in. thick brick walls or average quality glazed steel sash—but offers high heat resistance and other advantages materially reducing the expense of maintenance. The simple reinforcing method recommended combines complete effectiveness and economical installation. Prompt quotations will be furnished by an Owens-Illinois representative upon request. The cost of any material in place is the only basis for accurate comparison.

### ESTIMATING DATA

For 100 sq. ft. of wall	4 7/8 x 8 x 3 7/8	5 3/4 x 5 9/4 x 3 7/8	7 9/4 x 7 3/4 x 3 7/8
Thickness of Mortar Joint	1/4	1/4	1/4
Number of Blocks	241	400	225
Volume of Mortar Joints	2.47 cu. ft.	2.61 cu. ft.	1.96 cu. ft.
Crew Hours*	6 3/4	8	5 1/2
Thickness of Mortar Joint	3/16	3/16	3/16
Number of Blocks	348	409	229
Volume of Mortar Joints	1.88 cu. ft.	1.98 cu. ft.	1.48 cu. ft.
Crew Hours*	7 1/4	8 1/2	6

\*Crew consists of 1 mason, 2 helpers.



The simple mortar joint, made possible by the Owens-Illinois method of securing bond, makes the cost of erection and repair of Insulux Glass Masonry lower than if the bond depended upon an irregularly shaped mechanical key. Ordinary care in handling Insulux Glass Blocks on the job will result in a complete absence of breakage. No greater precautions are necessary than in the handling of fine face brick, terra cotta or cut stone.



**A few of the many products  
manufactured by Owens-Illinois**

**Glass Containers**

**Bottle Closures**

**Air Filter**

**Red Top**

**Electrical**

**Acoustical**

Digitized by:



ASSOCIATION  
FOR  
PRESERVATION  
TECHNOLOGY,  
INTERNATIONAL  
[www.apti.org](http://www.apti.org)

BUILDING  
TECHNOLOGY  
HERITAGE  
LIBRARY

<https://archive.org/details/buildingtechnologyheritagelibrary>

From the collection of:  
Robert Vail Cole Jr, AIA  
1962 - 2011



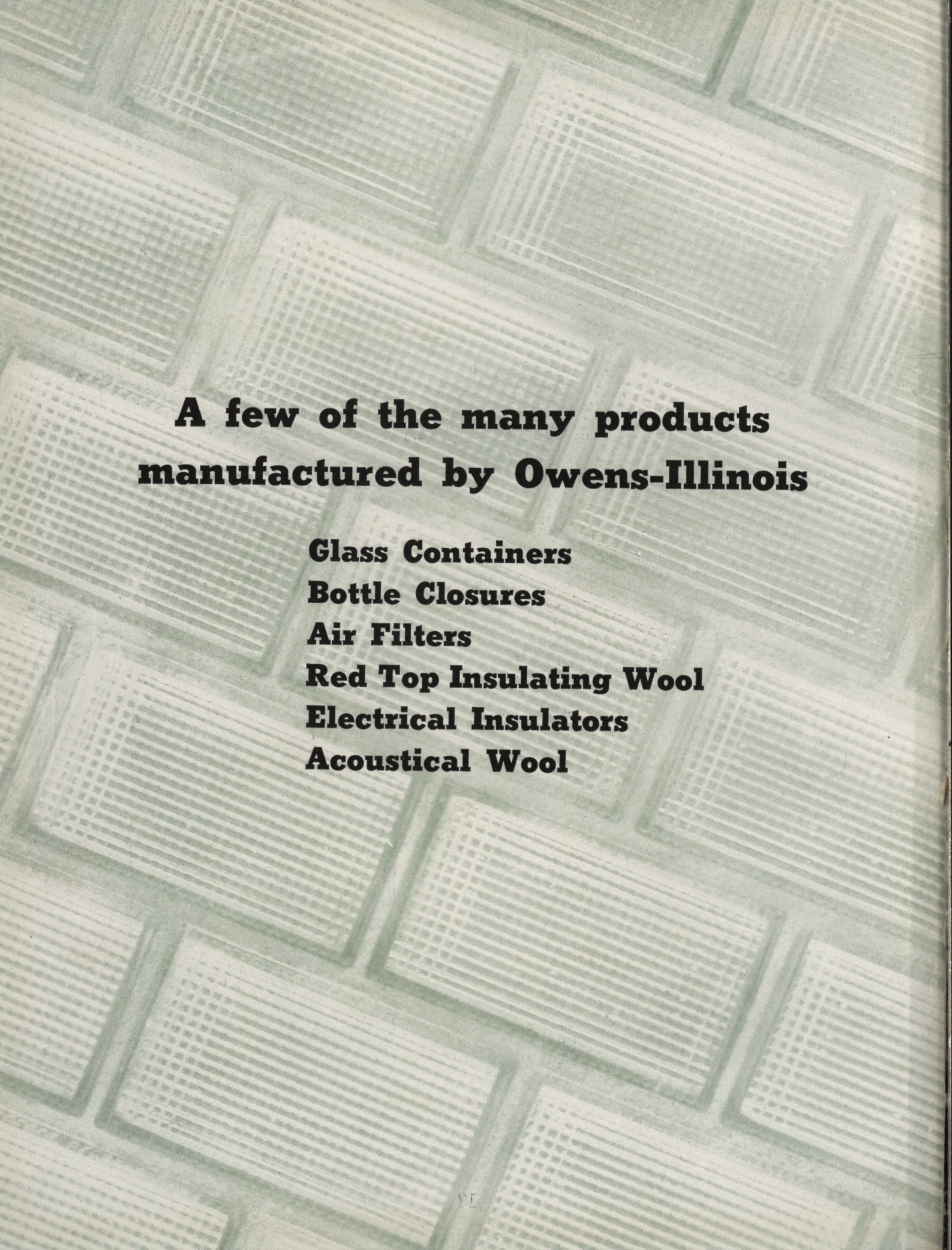

**A few of the many products  
manufactured by Owens-Illinois**

**Glass Containers**

**Bottle Closures**

**Air Filters**

**Red Top Insulating Wool**

**Electrical Insulators**

**Acoustical Wool**